



# 5400 Series

Grade 1 Cylindrical Knob Locks



## time-tested quality

### introduction

When demanding the highest standard of product performance in even the toughest industrial applications, look no further than the Yale® 5400 Series Heavy-Duty Grade 1 cylindrical locksets.

Yale high-quality key-in-knob locksets have withstood the test of time by offering the finest cylindrical lock mechanisms available. Even today, 5400 Series locksets are assembled with superbly engineered components and constructed with high-grade materials for long-lasting reliability.

Manufactured for the industrial, commercial and institutional markets, 5400 Series locksets feature security, dependability and versatility in attractive designs and finishes that fulfill all decorative requirements and blend with any architectural décor.

### ANSI/BHMA

Certified ANSI/BHMA A156.2, Series 4000 Grade 1.



### installation

5400 Series Cylindrical Locks conform to ANSI/BHMA Specifications A156.115 which cover hardware preparations for steel doors and steel frames and A156.115-W which cover hardware preparations for wood doors with wood or steel frames.

### door thickness

Adjustable for doors 1-3/8" (35mm) to 2" (51mm). Can be supplied by special order for doors over 2" (51mm) using special roses. These roses are limited to certain designs and must be specified on the order if other than standard 1-3/8" (35mm) to 2" (51mm) thickness.

### fire listings

5400 Series Cylindrical locksets are UL-cUL Listed for use on fire doors having a rating up to and including 3-hours.

Note: Any retrofit or other field modification to a fire rated opening can potentially impact the fire rating of the opening, and Yale Locks & Hardware makes no representations or warranties concerning what such impact may be in any specific situation. When retrofitting any portion of an existing fire rated opening, or specifying and installing a new fire-rated opening, please consult with a code specialist or local code official (Authority Having Jurisdiction) to ensure compliance with all applicable codes and ratings.

### split finishes

When locksets with different trim finishes on each side are required, specify the outside finish first and suffix by inside trim, i.e. LF5401 x 605 x 625. The front and strike are finished to match inside trim unless otherwise specified.

### warranty

The 5400 cylindrical knob lock carries a two-year warranty.

### microshield®

5400 Series Locks are available with *MicroShield* antimicrobial coating. *MicroShield* is a revolutionary hardware finish coating, using a silver ion based technology, which inhibits the growth of bacteria, algae, yeast, fungus, mold and mildew. *MicroShield* is non-toxic and lasts for the lifetime of the finish to which it is applied. To order, suffix option code "YMS". Available for 626 and 630 finishes, additional finishes by special application. Contact factory for availability.

Note: *MicroShield* coating may vary finish color from architectural standards. *MicroShield* is not intended as a substitute for traditional infection control programs such as hand hygiene or use of disinfectants. Coated products must still be cleaned to insure the surfaces will be free of destructive microbes. Yale makes no representations or warranties, express or implied, as to the efficacy of *MicroShield*.

### contents

- Introduction ..... 2
- Features ..... 2-3
- Knob Designs..... 4
- Functions ..... 5-6
- Cylinders ..... 7
- Latchbolts ..... 8
- Strikes ..... 9
- Knob and Rose Components ..... 10
- Ordering Information..... 11
- Sample Specification ..... 11

### ISO 9001

Designed and manufactured under a certified ISO 9001 quality system.

### finishes

ANSI/BHMA Code	Finish Description
605	Bright Brass, Clear Coated
606	Satin Brass, Clear Coated
609	Satin Brass, Blackened, Satin Relieved, Clear Coated <sup>1</sup>
611	Bright Bronze, Clear Coated
612	Satin Bronze, Clear Coated
613	Dark Oxidized Satin Bronze, Oil Rubbed <sup>2</sup>
616	Satin Bronze, Blackened, Satin Relieved, Clear Coated <sup>1</sup>
619	Satin Nickel Plated, Clear Coated
620	Satin Nickel Plated, Blackened, Satin Relieved, Clear Coated <sup>1</sup>
625	Bright Chrome Plated
626	Satin Chrome Plated
629	Bright Stainless Steel <sup>4</sup>
630	Satin Stainless Steel <sup>4</sup>
693	Black Painted
722	Black Oxidized Bronze, Oil Rubbed <sup>3</sup>

1. These finishes will be provided per factory standard. To assure color match, please provide a sample.
2. New May 1, 2010
3. Formerly 613 prior to May 1, 2010
4. Knobs are nickel plated to match stainless steel.

## features

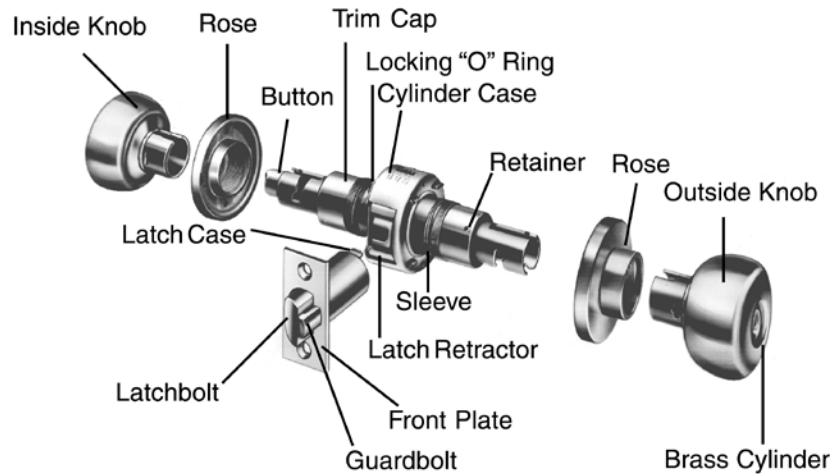

### quality construction

- Constructed of heavy-gauge cold-rolled steel
- All parts zinc plated chromate for maximum corrosion resistance
- Recommended for use under normal climactic and environmental conditions

### case

2-1/16" (52mm) diameter. All functions furnished in one standard size lock case.

### strike

1-1/4" (32mm) curved lip ANSI 497 supplied standard. Optional 1" (25mm), 1-1/2" (38mm), 1-3/4" (44mm) and 2" (51mm) curved lips with wrought boxes available to order.

### abrasive coating

Where required by the local authority, an abrasive coating can be applied to 5400 trim to be identifiable to the touch for blind persons. To order, specify "Abrasive Coating."

### backset

2-3/4" (70mm) standard. 3-3/4" (95mm), extension links for 5" (127mm), 6" (152mm), 7" (178mm), 8" (203mm), 18" (457mm), 19" (483mm), and up to 42" (1.06m) backset are available.

### windstorm

Certified (refer to local codes).



Hurricane

### latchbolt

1/2" (13mm) throw, deadlocking or plain, supplied standard. Optional 3/4" (19mm) deadlocking throw available to order. All latch units are interchangeable.

### lead-shielded locksets

Lead-shielding is intended to reduce emission of harmful rays through the door. Two 1/8" thick lead backup washers under each rose are furnished. Lead plug inserts are supplied in the knob spindles where lockset function permits. For maximum protection, plain knob operation is recommended on at least one side and preferably on both sides. To order, specify "Lead Shielded."



### knob designs

#### Carolina CA

**Knob:** Cast Zinc  
**Rose:** Cold Forged Brass, Bronze

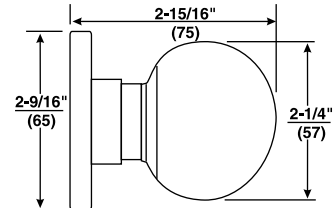

#### Litchfield LF

**Knob:** Cast Zinc  
**Rose:** Cold Forged Brass, Bronze

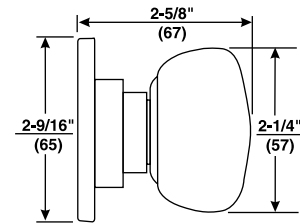

#### optional mayfair rose

**MF Rose:** Cold Forged Brass, Bronze

Available with all knob designs.

**How to order:**  
CA x MF  
LF x MF

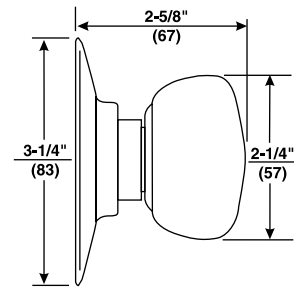

Litchfield knob shown.

Dimensions are shown in inches (millimeters).

functions

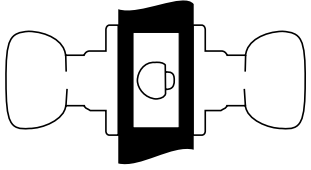
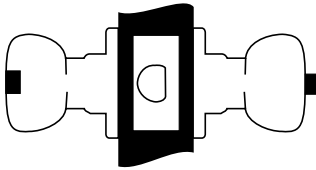
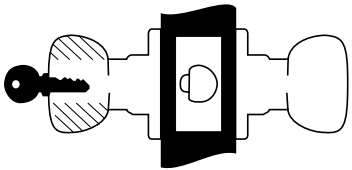
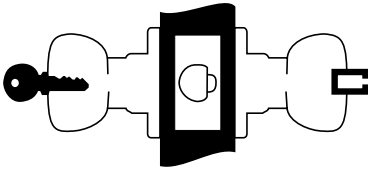
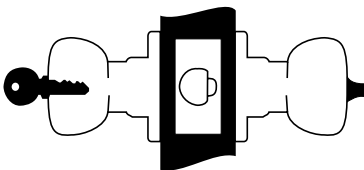
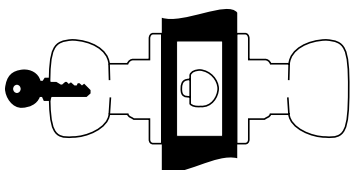
<p style="text-align: center;"><b>5401 (F75)</b></p> <p><b>Passage or Closet Latch</b></p> <ul style="list-style-type: none"> <li>• For doors that do not require locking.</li> <li>• Either knob operates latchbolt at all times.</li> </ul>  <p style="display: flex; justify-content: space-between;"><span>Outside</span><span>Inside</span></p>	<p style="text-align: center;"><b>5402 (F76A)</b></p> <p><b>Privacy, Bedroom or Bath Lock</b></p> <ul style="list-style-type: none"> <li>• For lavatory or other privacy doors.</li> <li>• Either knob operates latchbolt unless outside knob is locked by push-button inside.</li> <li>• Button automatically released when inside knob is turned or door is closed.</li> <li>• A coin inserted and turned in emergency slot will unlock door from outside.</li> <li>• Inside knob always active.</li> </ul>  <p style="display: flex; justify-content: space-between;"><span>Outside</span><span>Inside</span></p>	<p style="text-align: center;"><b>5405 (F86)</b></p> <p><b>Storeroom or Closet Lock</b></p> <ul style="list-style-type: none"> <li>• For use on storeroom, utility, exit doors.</li> <li>• Deadlocking latchbolt.</li> <li>• Latchbolt operated by knob inside, key in outside knob.</li> <li>• Outside knob always rigid.</li> <li>• Inside knob always active.</li> </ul>  <p style="display: flex; justify-content: space-between;"><span>Outside</span><span>Inside</span></p>
<p style="text-align: center;"><b>5406 (F92)</b></p> <p><b>Service Station Lock</b></p> <ul style="list-style-type: none"> <li>• Deadlocking latchbolt.</li> <li>• Either knob operates latchbolt.</li> <li>• Push-button locks outside knob.</li> <li>• Push-button automatically releases when inside knob is turned, door is closed, or key is rotated in outside knob (except when slotted push-button is rotated 90° clockwise to retain outside knob in lock position).</li> <li>• Lock opened by key in outside knob, inside knob always active.</li> </ul>  <p style="display: flex; justify-content: space-between;"><span>Outside</span><span>Inside</span></p>	<p style="text-align: center;"><b>5407 (F109)</b></p> <p><b>Entry Lock</b></p> <ul style="list-style-type: none"> <li>• For entrance, general home or office doors.</li> <li>• Deadlocking latchbolt.</li> <li>• Either knob operates latchbolt (except when outside knob is locked from inside).</li> <li>• Pushing turn button in inside knob locks outside knob (automatically releases when inside knob is turned or key is rotated in locked outside knob).</li> <li>• Outside knob may be retained in locked position by pushing and rotating turn button 90° clockwise to a horizontal position; not released until turn button is manually returned to the vertical position.</li> <li>• Latchbolt is operated by key in outside knob or by rotating inside knob.</li> <li>• Inside knob always active.</li> </ul>  <p style="display: flex; justify-content: space-between;"><span>Outside</span><span>Inside</span></p>	<p style="text-align: center;"><b>5408 (F84)</b></p> <p><b>Classroom Lock</b></p> <ul style="list-style-type: none"> <li>• For classroom or utility room doors.</li> <li>• Deadlocking latchbolt.</li> <li>• Either knob operates latchbolt (except when outside knob is locked by key).</li> <li>• Inside knob is always active.</li> <li>• Key releases outside knob.</li> </ul>  <p style="display: flex; justify-content: space-between;"><span>Outside</span><span>Inside</span></p>

functions

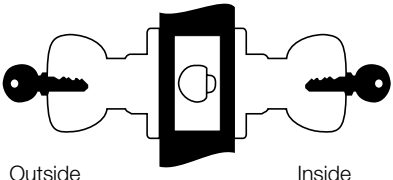
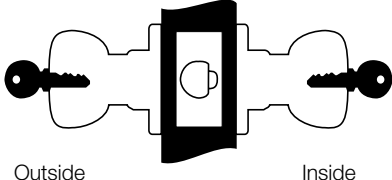
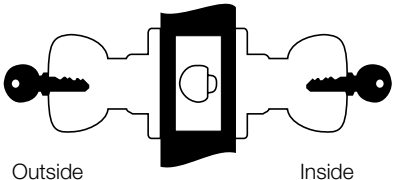
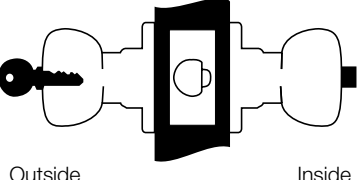
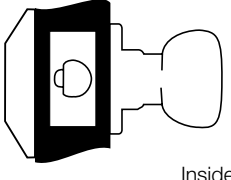
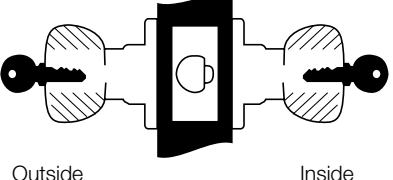
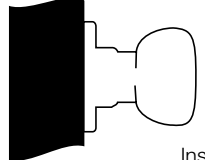
<p style="text-align: center;"><b>5417 (F88)</b></p> <p><b>Apartment, Exit or Public Toilet Lock</b></p> <ul style="list-style-type: none"> <li>• For office or apartment building entrance doors or lavatory doors.</li> <li>• Deadlocking latchbolt.</li> <li>• Either knob operates latchbolt (except when outside knob is locked from inside).</li> <li>• Key in outside knob operates latchbolt.</li> <li>• Inside knob always active.</li> </ul>  <p style="display: flex; justify-content: space-between;"><span>Outside</span><span>Inside</span></p>	<p style="text-align: center;"><b>5419 (F91)</b></p> <p><b>Store Door Lock</b></p> <ul style="list-style-type: none"> <li>• For store entrance or communicating doors.</li> <li>• Deadlocking latchbolt.</li> <li>• Either knob operates latchbolt (except when both knobs are locked simultaneously by key in either knob).</li> </ul>  <p style="display: flex; justify-content: space-between;"><span>Outside</span><span>Inside</span></p>	<p style="text-align: center;"><b>5421 (F80)</b></p> <p><b>Communicating Lock</b></p> <ul style="list-style-type: none"> <li>• For communicating or store entrance doors.</li> <li>• Deadlocking latchbolt.</li> <li>• Either knob operates latchbolt (except when key in either knob locks or unlocks the knob independently of the other).</li> <li>• Should be used only on offices or rooms with multiple entry.</li> </ul>  <p style="display: flex; justify-content: space-between;"><span>Outside</span><span>Inside</span></p>
<p style="text-align: center;"><b>5422 (F90)</b></p> <p><b>Corridor Lock</b></p> <ul style="list-style-type: none"> <li>• Deadlocking latchbolt.</li> <li>• Either knob operates latchbolt (except when outside knob is locked by inside push-button or key in outside knob).</li> <li>• Inside knob always active.</li> <li>• When locked by button, the button automatically releases when inside knob is turned or door is closed.</li> <li>• When locked by key, the automatic release is made inoperative and must be manually unlocked by key.</li> </ul>  <p style="display: flex; justify-content: space-between;"><span>Outside</span><span>Inside</span></p>	<p style="text-align: center;"><b>5428 (F111)</b></p> <p><b>Communicating Passage Lock</b></p> <ul style="list-style-type: none"> <li>• For twin communicating or exit door where one-side operation is required.</li> <li>• For use when space is limited between door and switch panel.</li> <li>• Deadlocking latchbolt.</li> <li>• One knob operation.</li> <li>• Blank rose.</li> <li>• Should be used where rooms have more than one entrance.</li> </ul>  <p style="display: flex; justify-content: space-between;"><span>Outside</span><span>Inside</span></p>	<p style="text-align: center;"><b>5430 (F87)</b></p> <p><b>Utility, Asylum or Institutional Lock</b></p> <ul style="list-style-type: none"> <li>• Latchbolt operated by key in knob from either side.</li> <li>• Deadlocking latchbolt.</li> <li>• Both knobs always rigid.</li> </ul>  <p style="display: flex; justify-content: space-between;"><span>Outside</span><span>Inside</span></p>
<p style="text-align: center;"><b>455</b></p> <p><b>Dummy Trim</b></p> <ul style="list-style-type: none"> <li>• For non-operational knobs used for decorative trim.</li> </ul>  <p style="display: flex; justify-content: space-between;"><span>Outside</span><span>Inside</span></p>		



## cylinders

### cylinder options

The following selection guide indicates the correct cylinder for each locking segment.

Lockset Series: 5400		Types of Cylinder Mechanisms								
		Conventional		Protected Keyway		Security		High Security		
Cylinder Types	Fixed Core	6-pin	7-pin	6-pin	7-pin	6-pin	7-pin	6-pin	7-pin	
	Key-In-Knob	1801	1801A CA only	K400	K400 CA only	5801	5801A CA only	N/A	N/A	
	<b>Interchangeable Core</b>									
	LFIC	1210 CA only	N/A	K800 CA only	N/A	5210 CA only	N/A	N/A	N/A	
SFIC	N/A	N/A	K600 CA only	K600 CA only	N/A	N/A	N/A	N/A		

Refer to Yale® KeyMark® and/or Cylinders and Keys Catalog sections for all details and how to order examples.

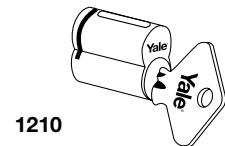
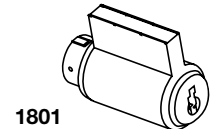

### Yale® KeyMark®

For those applications requiring protected key control, Yale® KeyMark® cylinders guard against unauthorized key duplication. The *Yale KeyMark Security Leg®* keyway feature increases resistance against picking and impressing and can easily retrofit into existing systems. For further details and availability, refer to the separate *Yale KeyMark* catalog.

### security cylinders

Security cylinders contain two independent locking mechanisms. The first is a traditional 6 or 7-pin tumbler mechanism with spool drivers for greatly increased picking resistance.

The second is an innovative 5-tumbler rotating disc mechanism with sidebar engagement. The rotating discs are spring loaded and block the bottom of the keyway.

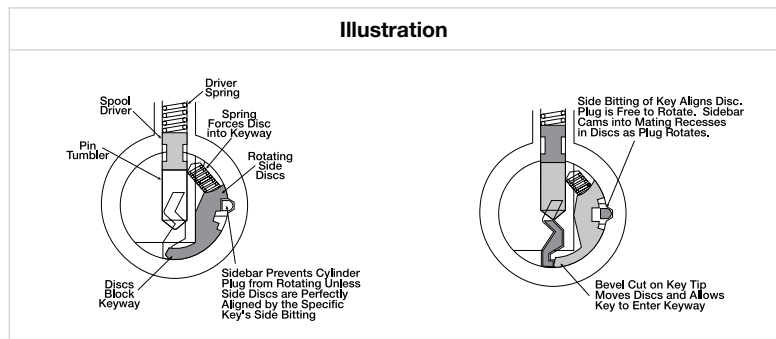

### other cylinder options

	Description	Model Number or Prefix	Number of Pins
	Best® Keyway Cylinder. Available keyed random, master keyed or uncombined. Specify keyway A, B, C, D, E, F, G, H, J, K, L or M.	A600*	6 or 7
	Schlage® "C" Keyway. Available 0-bitted or keyed random.	2801	6
	Knob accepting all SFIC.	B* (i.e. B-CA)	6 or 7

\*Available in Carolina (CA) design only.



## latchbolts

### plain latchbolts

Model No. 693 supplied standard with all 5400 series locksets without locking function. Standard plain latchbolt has a 2-1/4" (57mm) x 1-1/8" (29mm) beveled front with a 2-3/4" (70mm) backset and a 1/2" (13mm) bolt throw. Optional latchbolts with a greater backset/throw available to special order.

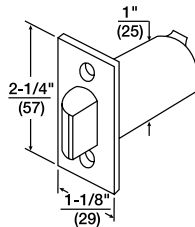

Model No.	Front	Backset	Throw	Front Width	Latch Diameter
693	Beveled	2-3/4" (70mm)	1/2" (13mm)	1-1/8" (29mm)	1" (25mm)
F693	Flat	2-3/4" (70mm)	1/2" (13mm)	1-1/8" (29mm)	1" (25mm)
3693	Beveled	3-3/4" (95mm)	1/2" (13mm)	1-1/8" (29mm)	1" (25mm)

**Note: For 3/4" throw applications, only deadlocking latchbolts available.**

### deadlocking latchbolts

Deadlocking latchbolt Model No. 694 supplied standard with all 5400 series locksets with locking function. Standard deadlocking latchbolt has a 2-1/4" (57mm) x 1-1/8" (29mm) beveled front with a 2-3/4" (70mm) backset and a 1/2" (13mm) bolt throw. Optional latchbolts with a greater backset/throw available to special order.

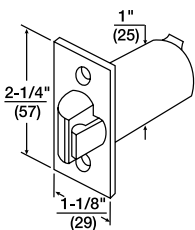

Model No.	Front	Backset	Throw	Front Width	Latch Diameter
694	Beveled	2-3/4" (70mm)	1/2" (13mm)	1-1/8" (29mm)	1" (25mm)
F694	Flat	2-3/4" (70mm)	1/2" (13mm)	1-1/8" (29mm)	1" (25mm)
3694	Beveled	3-3/4" (95mm)	1/2" (13mm)	1-1/8" (29mm)	1" (25mm)
480B	Beveled	2-3/4" (70mm)	3/4" (19mm)	1-1/8" (29mm)	1" (25mm)
F480B	Flat	2-3/4" (70mm)	3/4" (19mm)	1-1/8" (29mm)	1" (25mm)
3480B	Beveled	3-3/4" (95mm)	3/4" (19mm)	1-1/8" (29mm)	1" (25mm)

### backset extension links

All 5400 Series locksets are supplied with standard latchbolts of 2-3/4" (70mm) backset; optional latchbolts with a 3-3/4" (95mm) backset are available to special order. Extension links are also available for attachment to 2-3/4" (70mm) or 3-3/4" (95mm) backset latchbolts to extend the backset to the desired length.

Desired Backset	Latchbolt Backset	Order Extension List No.
5" (127mm)	2-3/4" (70mm)	481DL
6" (152mm)	3-3/4" (95mm)	481
7" (178mm)	2-3/4" (70mm)	482
8" (203mm)	3-3/4" (95mm)	482
18" (46cm)	2-3/4" (70mm)	484
19" (48cm)	3-3/4" (95mm)	484

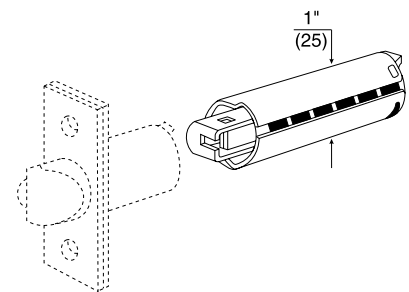

**Other extension links up to 42" (1.06m) backset are available to special order.**

### attaching screws

(Not regularly supplied when latchbolts ordered separately).

- **For all latchbolts**

- #8-8-32 x 3/4" (19mm) Phillips flat head combination wood and machine screws
- Brass - P/N 81-2022-0416\*
- Bronze - P/N 81-2032-0416\*

- **Hollow Metal Doors**

- #8 - 32 x 1" (25mm) Phillips flat head machine screw
- Brass - P/N 81-0022-0420\*
- Bronze - P/N 81-0032-0420\*

**\*Specify finish required.**



## strikes

Yale® 5400 locks are available with a variety of strike options. All strikes are located on the same vertical and horizontal center lines as the latchbolt. Some strikes are available in special lip lengths to accommodate varying thickness of doors and frames. To determine the proper length of the lip, measure from the center line of the strike to the edge of the jamb, accounting for any interfering trim (i.e. wood molding) and then add 1/4" (6mm) for curved lip. All strikes are reversible. Strikes are fabricated of either brass, bronze or stainless steel, depending on the lockset trim finish. When ordering strikes separately, specify the finish required.

<p><b>Model No. 497 ANSI Strike (Standard)</b>            1-1/4" supplied standard. 1-1/8", 1-1/2", and 1-3/4" lip lengths available by special order. For door and frames with ANSI/BHMA A156.115 preparations.</p>	<p><b>Model No. 495 Strike (Optional)</b>            1-1/4" curved lip, strike box supplied. 1", 1-1/2", 1-3/4" and 2" curved lip lengths available by special order. Anti-rattle tab.</p>	<p><b>Model No. 497B Blank ANSI Strike (Optional)</b>            Available to special order. Installed in frame with standard ANSI/BHMA A156.115 preparation to replace the strike when the lockset has been removed from the door.</p>	<p><b>Model No. 202 Strike Box for ANSI Strike (Optional)</b>            Specify 497 x 202</p>

## attaching screws

(Not regularly supplied when strikes ordered separately).

### For Model No. 495 strike

#8-8-32 x 3/4" (19mm) Phillips flat head combination wood and machine screw P/N-81-2012-9416.

### For Model No. 497 strike and 497B plate

#12-12-24 x 1" (25mm) Phillips flat head combination wood and machine screw P/N-81-2012-0620.

**Note: When ordering strike plates or attaching screws individually, specify the finish required; i.e. 497 x 202 x 612; #81-2012-0620 x 612.**



## knob and rose components

### 5400 knob\*

For all knob designs except as noted. Prefix number with design symbol, i.e. CA450

450 Plain

450F Plain (Rigid)

450P For Button

450K For Cylinder (6-pin or 7-pin^)

450KF For Cylinder (Fixed 6-pin or 7-pin^)

**^Available in CA design only.**

### large format interchangeable core knobs\*

CA design only. Prefix number with design symbols, i.e. CA450R

450R for large format interchangeable core (6-pin)

450RF for large format interchangeable core (fixed 6-pin)

### 5400 roses\*

For all rose designs. Prefix number with design symbol, i.e. CO451

451 Outside; for 1-3/8" to 2" doors.

452 Outside; for doors over 2" to 2-1/4" (for CO only).

453 Inside; for 1-3/8" to 2" doors.

454 Inside; for doors over 2" to 2-1/4".

### blank rose (brass or bronze only)

458 Outside (5428); for 1-3/4" doors

### locking "O" ring

For the inside sleeve of all locksets:

#99-9999-3665.



### knob caps\*

LF design:

#14-5401-0028

CA design:

#14-5404-2615

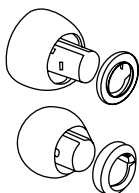

### trim caps\*

LF design:

#14-5401-2001 Brass

#14-5401-3001 Bronze

CA design:

#14-5401-2614 Brass

#14-5401-3614 Bronze



**\*Specify finish required, i.e. #14-5401-3001 x 612.**



## ordering information/sample specification

**From this outline select the Model Number for the Yale® 5400 Series locksets you require.**

Design	Function	Cylinder	Hand	Latch	Strike	Door Thickness	Finish	Keying Level	Supplementary Specifications
See page 4	See pages 5-6	See page 7	RH, LH, RHR, LHR	See page 8	See page 9	See page 2	See page 2	Highest Keying Level: "Level One" - KA or KD "Level Two" - MK "Level Three" - GM "Level Four" - GGM	Lead-lined, flat front, specific keying. Special rose and spacer plates. 7-pin cylinder. Extension links, strike lip, length, etc. (Specify by model number where available, see index for page references.)

## ordering example

Quantity	Design	Function	Cylinder	Hand	Latch	Strike	Door Thickness	Finish	Keying Level
100	CA	5407	1801	RH	480B	497	1-3/4"	626	MK

## packaging

Yale 5400 Series locksets are completely assembled at the factory. Each box has a strike, paper template, combination wood and machine screws and easy-to-follow instructions. Cylinder functions are supplied with two keys and furnished right hand unless otherwise specified. Each case contains spanner wrenches for use in installing locksets. There are ten unit cartons to a master carton or case.

## sample specification

All locksets shall be 5400 Series Grade 1 cylindrical knob locksets as assembled by Yale Locks & Hardware.

Lockset mechanisms are to be constructed of heavy-gauge cold-rolled steel, zinc plated chromate to protect against rust and corrosion. Locksets shall be adjustable to fit doors between 1-3/8" (35mm) to 2" (51mm) thick.

Locksets shall be reversible for either right hand or left hand doors and be easily installed with out the use of any special tools. They shall be installed in a 2-1/8" face bore and a 1" hole in the edge of the door.

Outside knob on keyed locksets shall be removable only when the designated key is in the cylinder.

Locksets shall have the capability of accepting 6 or 7-pin standard component cylinder, interchangeable core and security cylinders to provide expansion capacity for large masterkey systems.

Latchbolts shall be stainless steel and have a standard 1/2" throw.

Locksets shall carry a 2-year mechanical warranty.

Locksets shall comply with the following certification:

- UL/cUL up to and including 3 hours fire rating
- ANSI/BHMA A156.2 series 4000 Grade 1
- ANSI/BHMA A156.115 or A156.115-W preparation



## online literature and templates

---

For the latest information on Yale Locks & Hardware products, visit our website at: [www.yalelocks.com](http://www.yalelocks.com)

Click on the "Product Information" button to find:

- Catalogs
- Parts manuals
- Templates
- Specifications
- Installation instructions

Yale® customers can click on the ebusiness symbol  on the website to register for an ebusiness account to:

- Check the status of orders
  - Check availability of QuickShip items
  - Track your order and confirm delivery
  - Receive email notification of template changes
- And More...

Or contact us at:

### U.S.A.

#### Yale Locks & Hardware

Address: 225 Episcopal Road, Berlin, CT 06037-4004

Tel: 1-800-438-1951 • Fax: 1-800-338-0965 • [www.yalelocks.com](http://www.yalelocks.com)

### Canada:

#### ASSA ABLOY Door Security Solutions Canada

Address: 160 Four Valley Drive, Vaughan, Ontario L4K 4T9

Tel: 1-800-461-3007 • Fax: 1-800-461-8989 • [www.assaabloy.ca](http://www.assaabloy.ca)

### International:

#### ASSA ABLOY Americas International

Tel: 1-905-821-7775 • Fax: 1-905-821-1429 • [www.assaabloyai.com](http://www.assaabloyai.com)

Yale Locks & Hardware is a division of Yale Security Inc., an ASSA ABLOY Group company.

Yale® and MicroShield® are registered trademarks of Yale Security Inc., an ASSA ABLOY Group company. KeyMark® and Security Leg® are registered trademarks of Medeco Security Locks, Inc., an ASSA ABLOY Group company. Other products' brand names may be trademarks or registered trademarks of their respective owners and are mentioned for reference purposes only. These materials are protected under U.S. copyright laws. All contents current at time of publication. Yale Security Inc. reserves the right to change availability of any item in this catalog, its design, construction, and/or its materials. Copyright © 2002, 2012, Yale Security Inc., an ASSA ABLOY Group company. All rights reserved. Reproduction in whole or in part without the express written permission of Yale Security Inc., an ASSA ABLOY Group company is prohibited.

**YALE**, with its unique global reach and range of products, is the world's favorite lock.

**ASSA ABLOY** is the global leader in door opening solutions, dedicated to satisfying end-user needs for security, safety and convenience.

42126-9/12R